

□22 mm, offset 105 mm

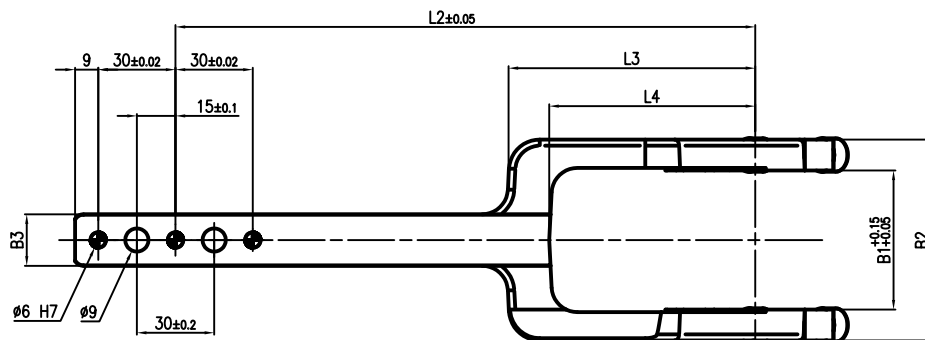
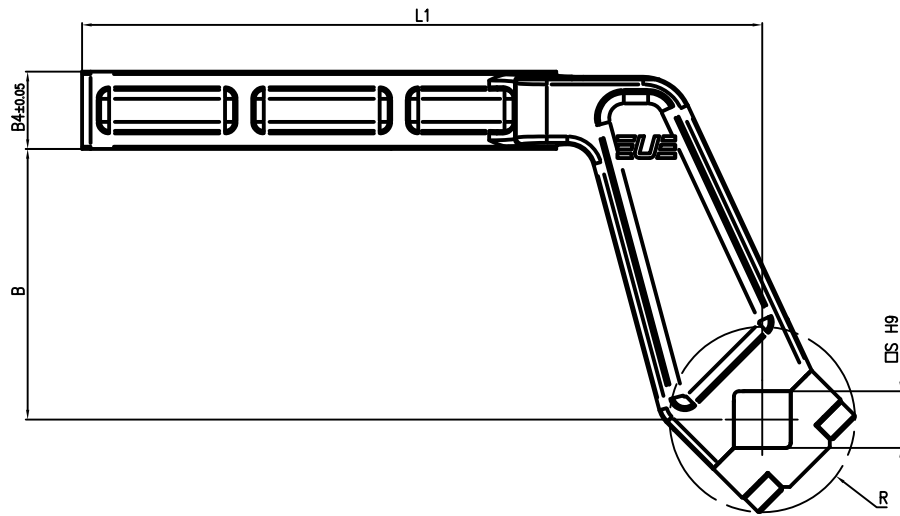

LKP-Code	B	B1	B2	B3	B4	L1	L2	L3	L4	R	S	Material
LKP010-2308	105	54	78	20	30	204	165	95	80	36	22	Steel
LKP010-2309	105	54	78	20	30	264	225	95	80	36	22	Steel